

PERGOLA 300X250X216DE ALTURA

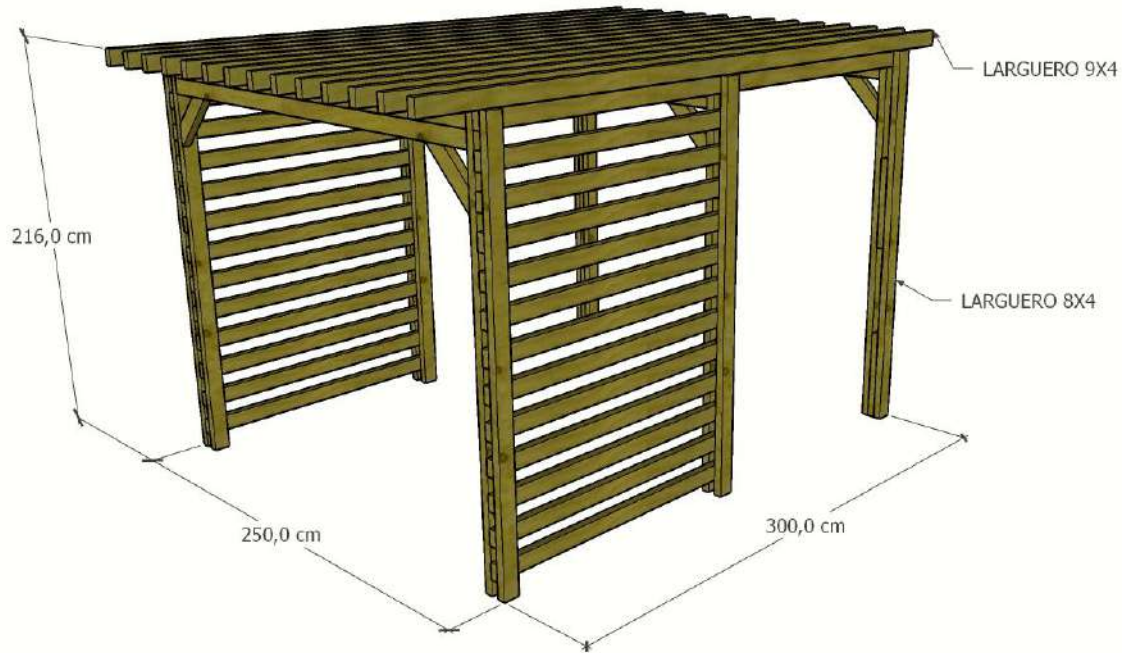

PASO 1 ARMADO DE PANELES

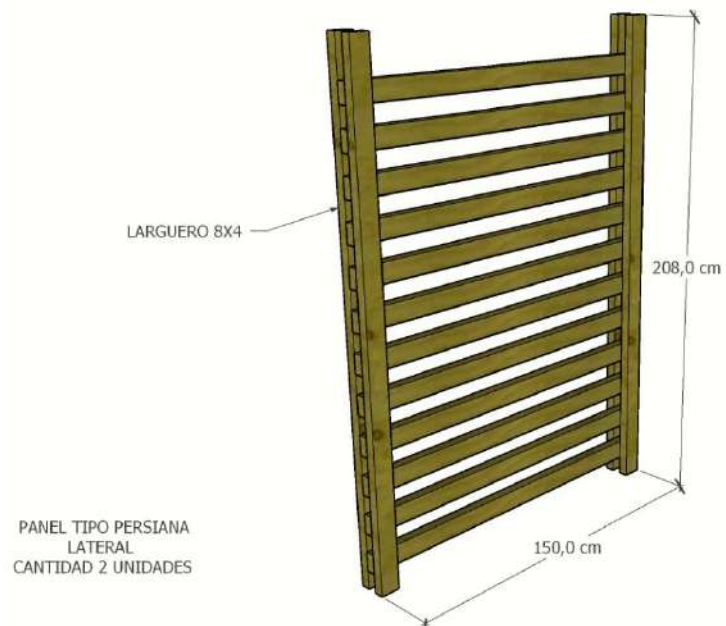

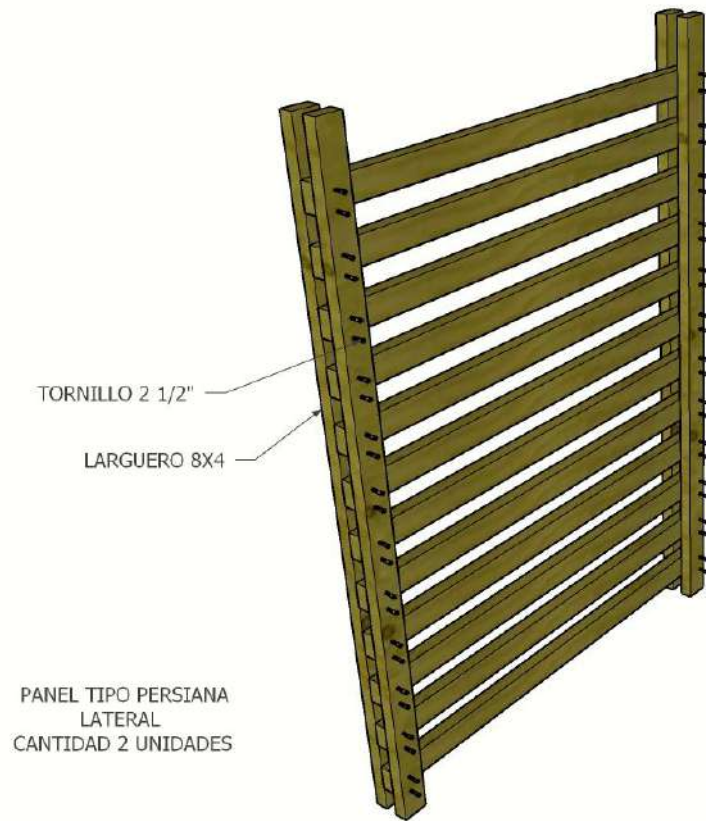
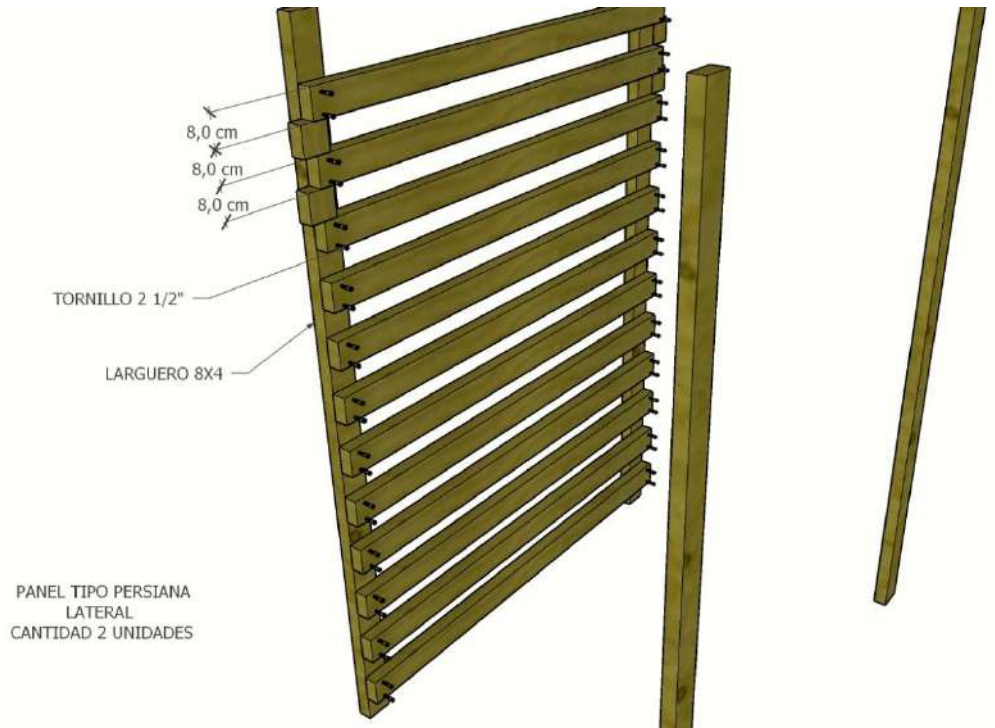

PASO 2 ARMADO DE COLUMNAS

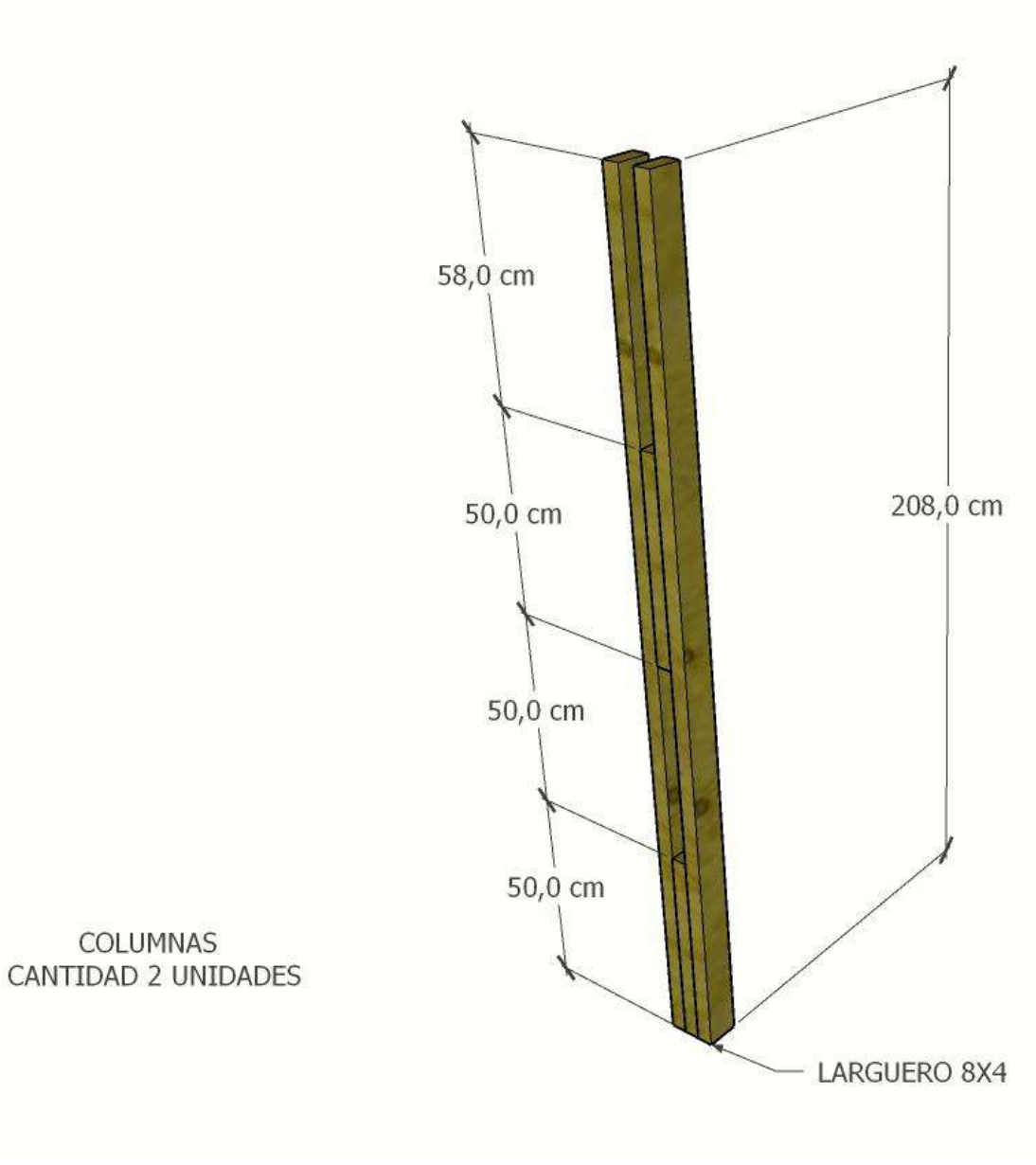

COLUMNAS
CANTIDAD 2 UNIDADES

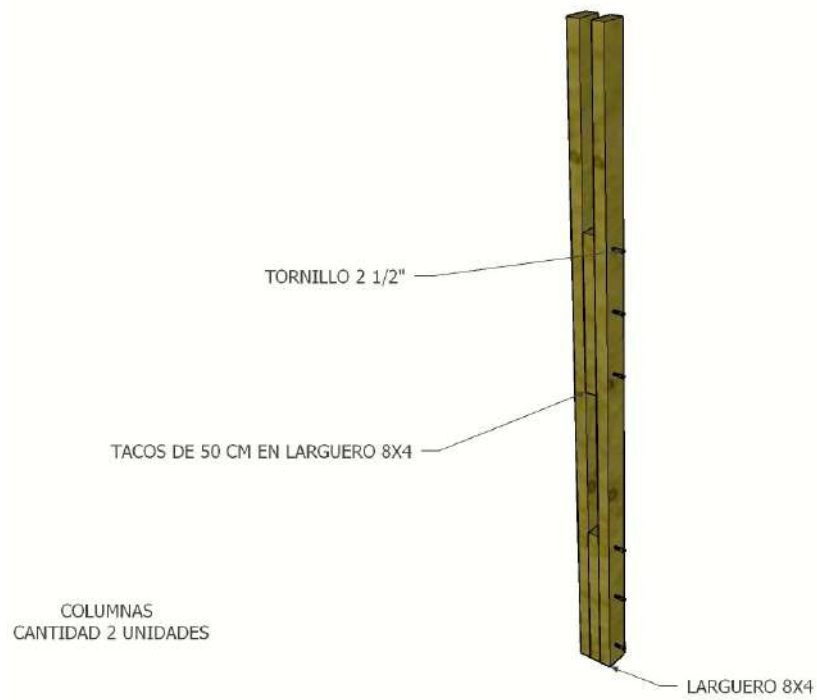
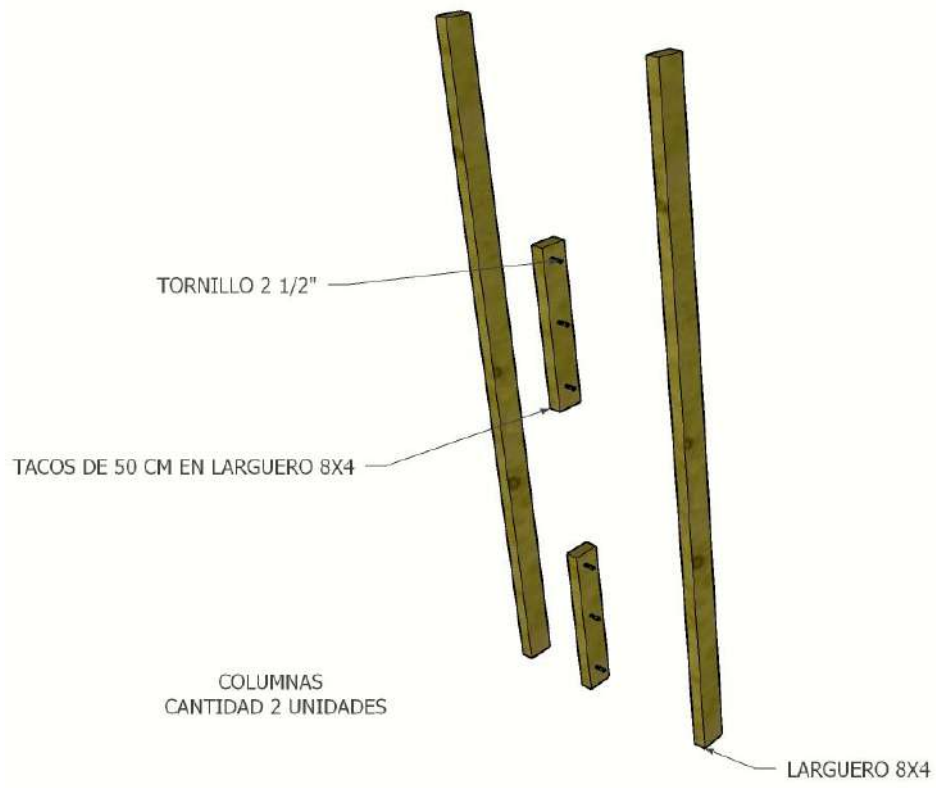

PASO 3 AMARRE PANELES Y COLUMNAS

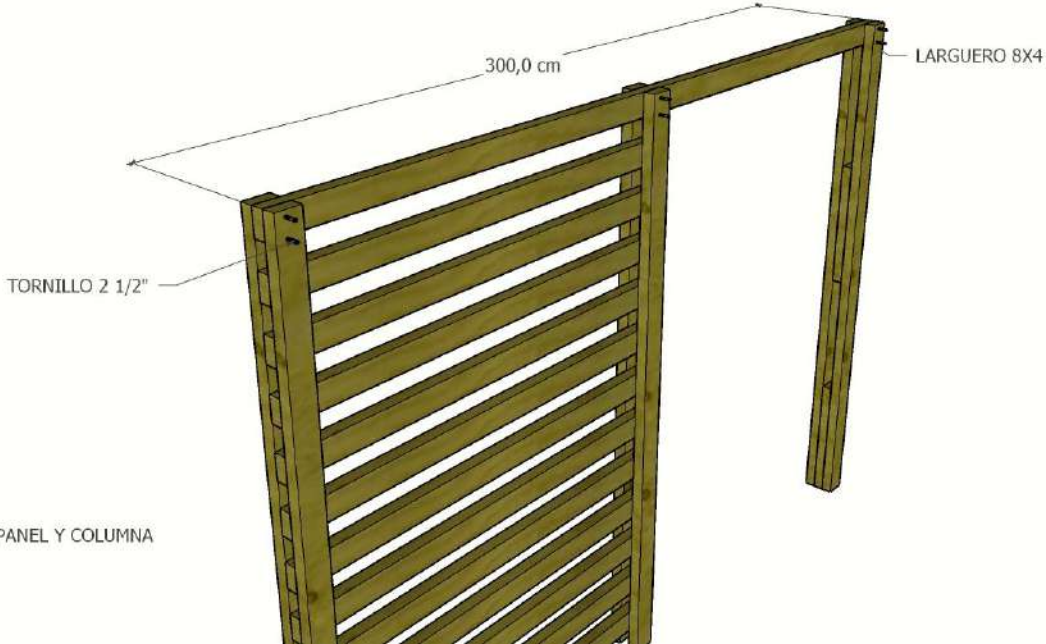
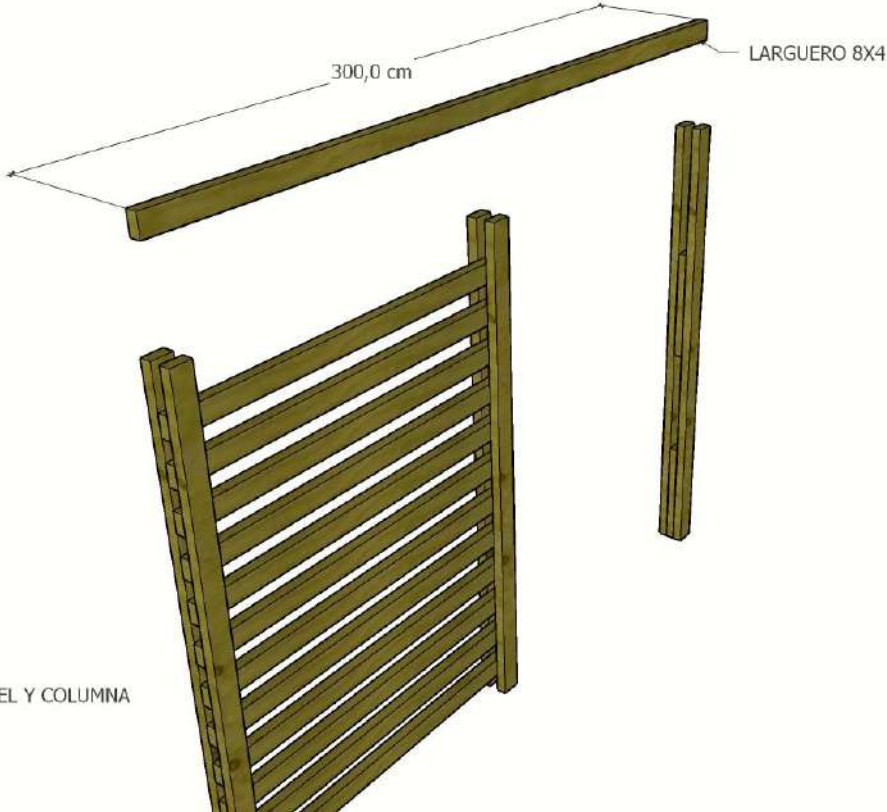

PASO 4 AMARRE PANELES LATERALES

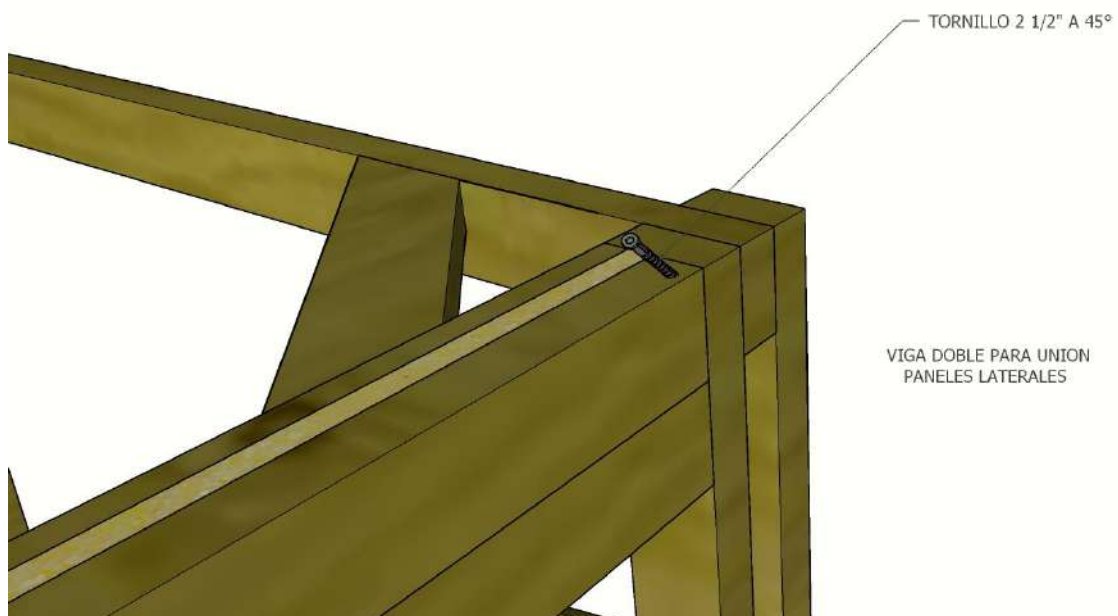
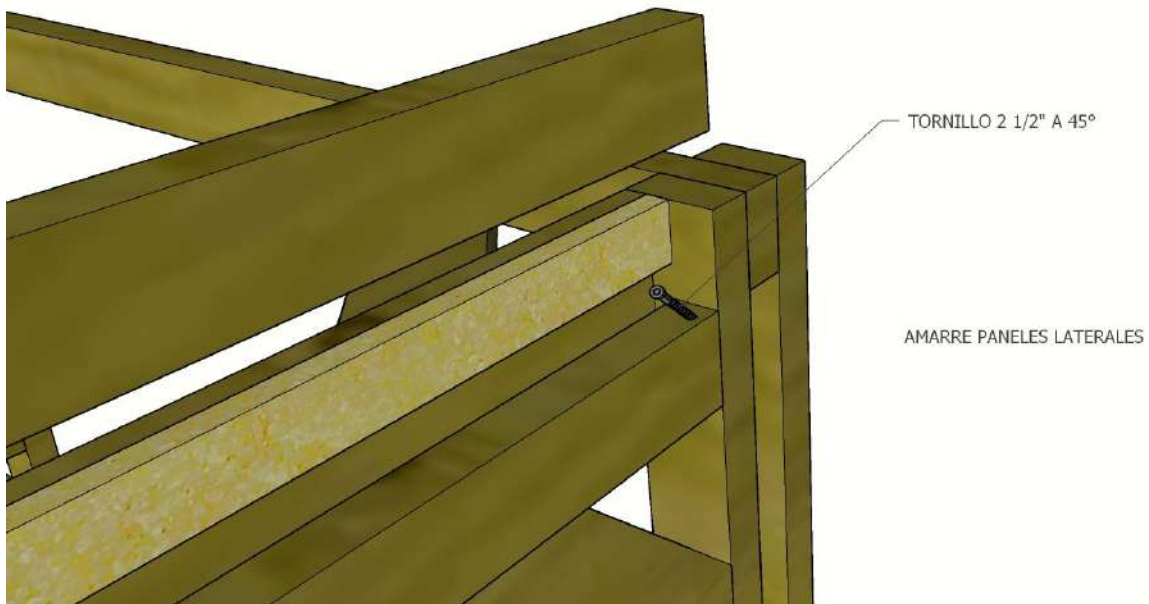

PASO 5 INSTALACION PIE DE AMIGOS

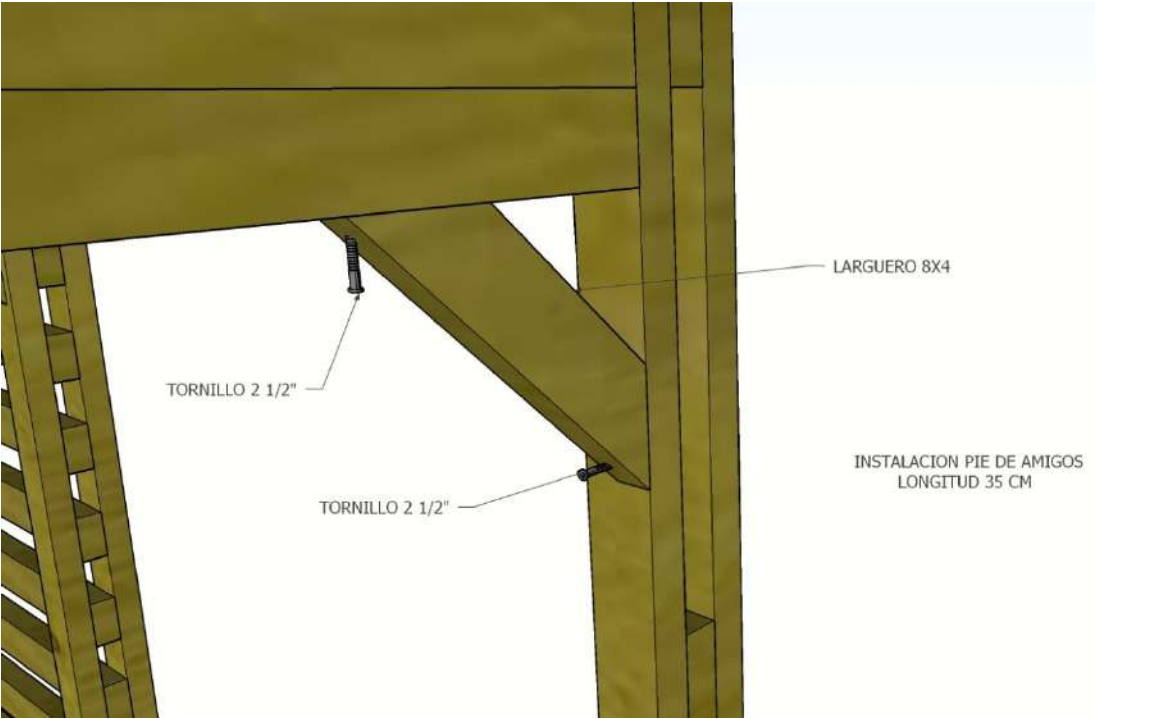
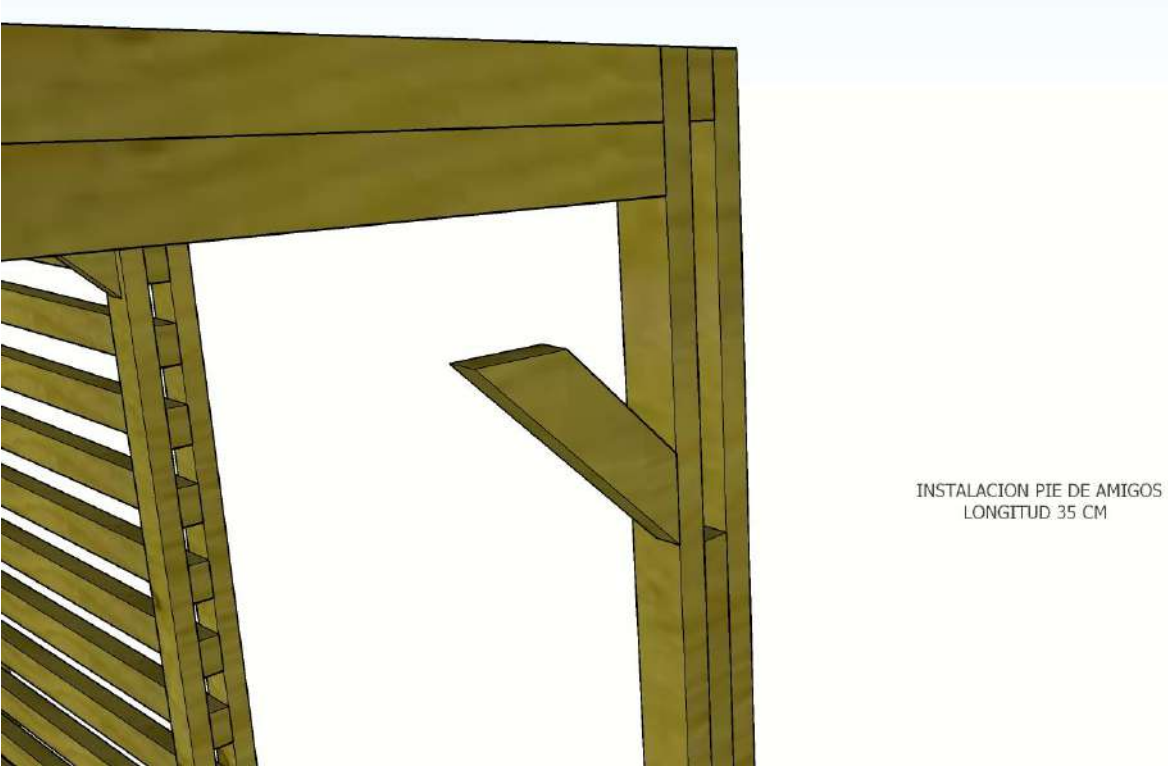

PASO 6 INSTALACION REFUERZO METALICO VIGA

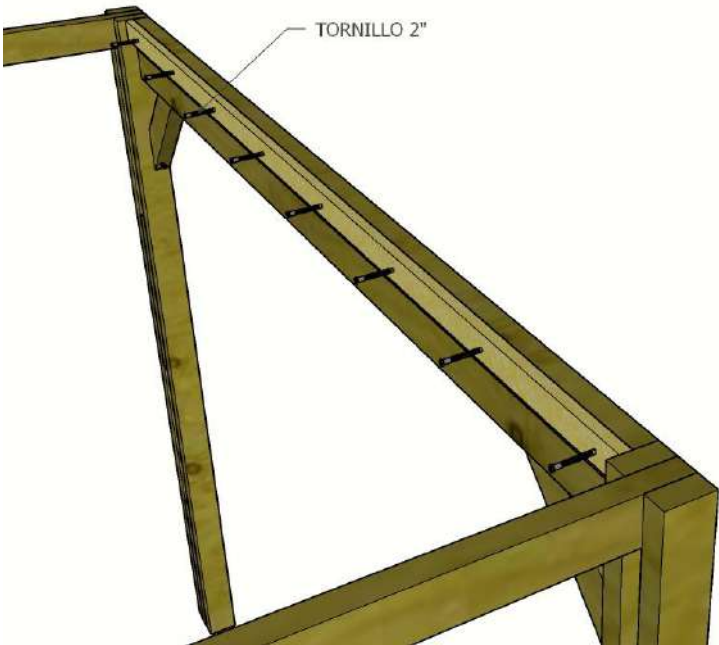
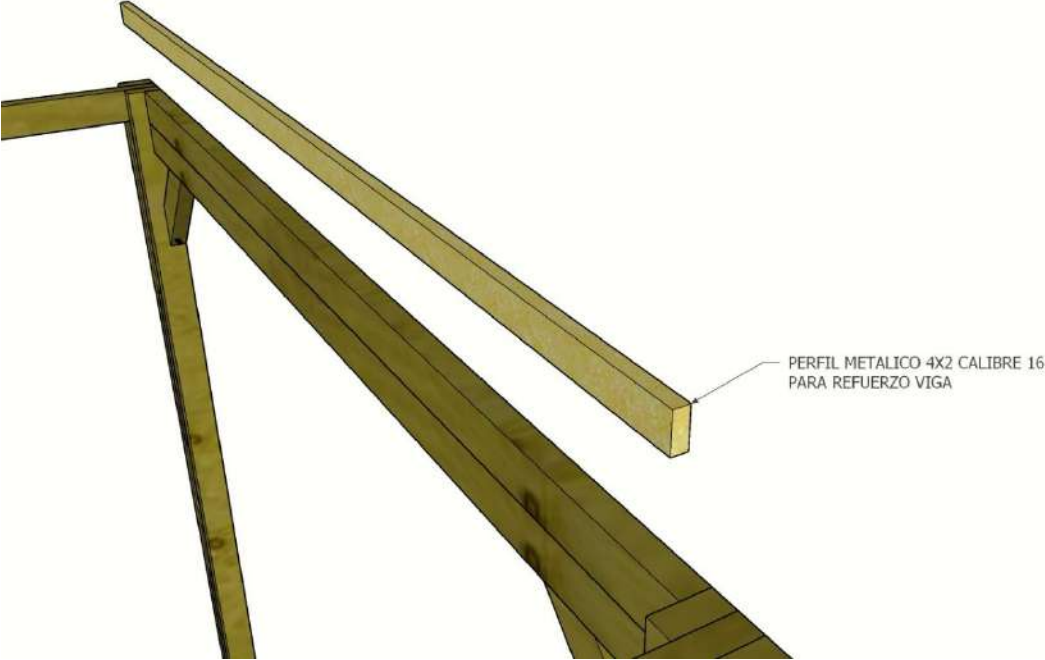

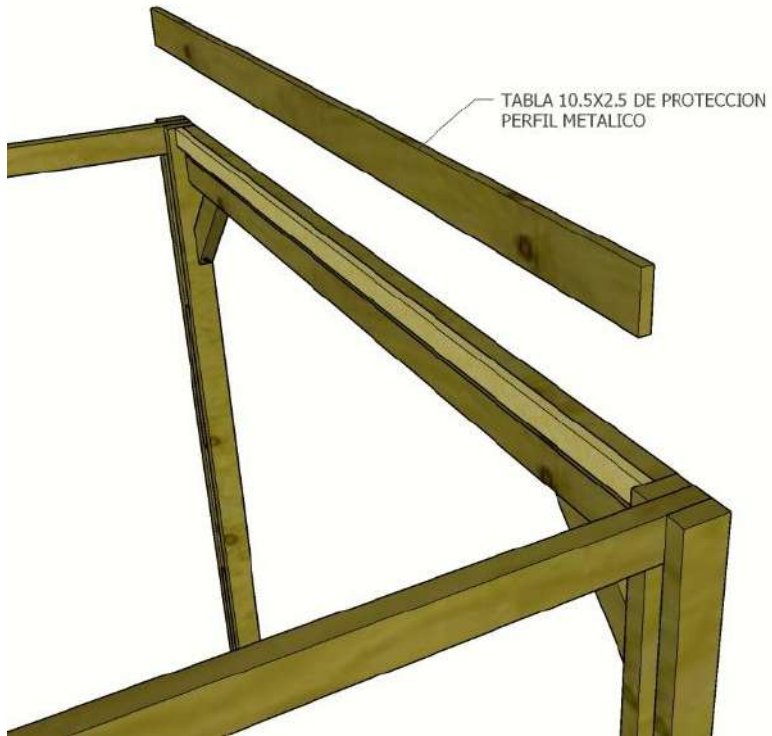

PASO 7 INSTALACION PERFLERIA CUBIERTA

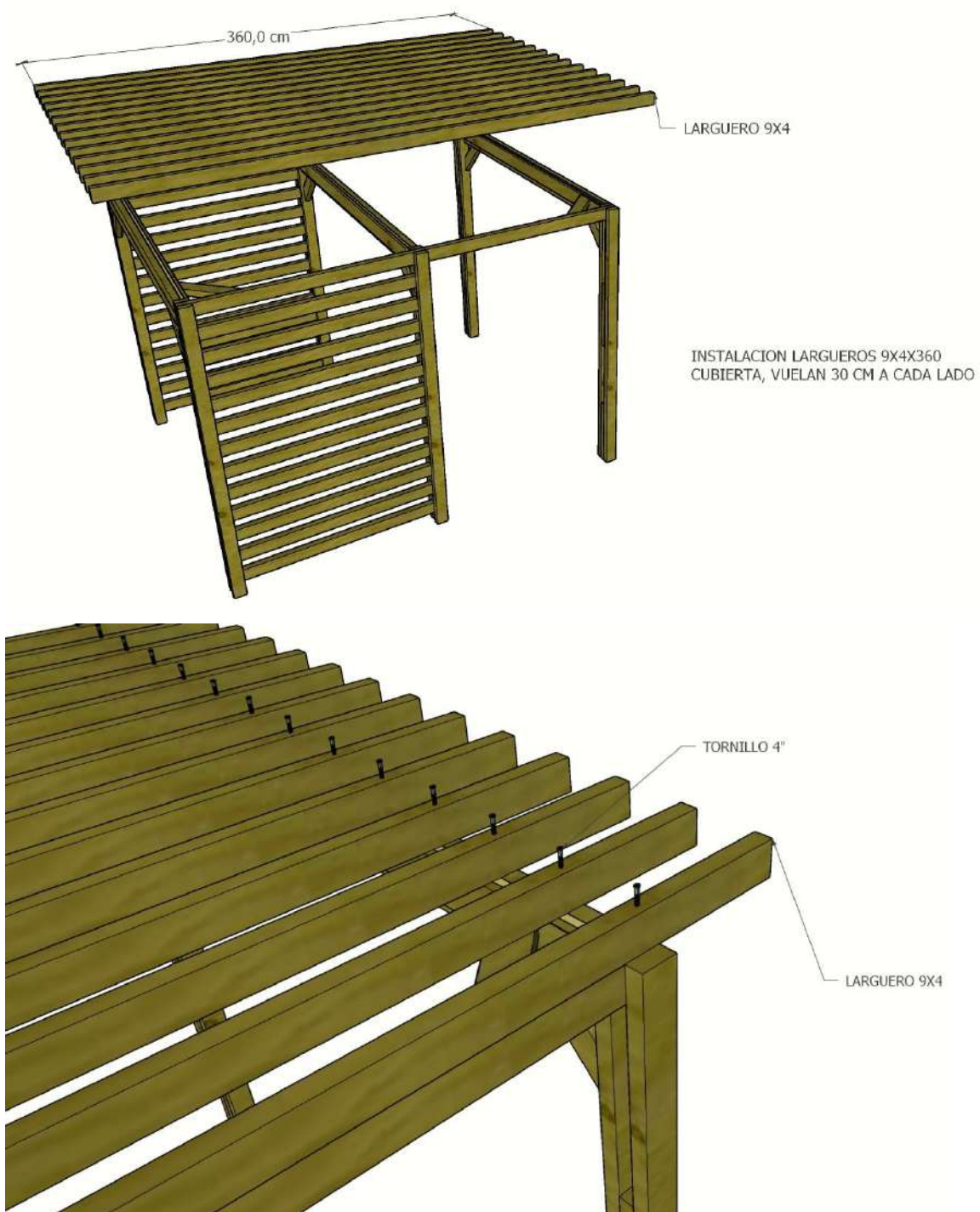

SKU	PRODUCTO	CANT.
465073	Tabla 10,5x2,5x300cm	3
465078	Larguero 8x4x300cm	32
465080	Larguero 9x4x360cm	14
	Tornillo 2 ½"	500
	Tornillo 2"	100
	Tornillo 4"	60

HERRAMIENTAS

ACOLILLADORA



TALADRO O ATORNILLADOR



SIERRA CIRCULAR



RUTEADORA



HERRAMIENTA DE MANO

